

GREENCABLE® LIGHT
FASSADENBEGRÜNUNGSSYSTEM
FACADE GREENING SYSTEM





DER INHALT IM ÜBERBLICK

- 03 _____ Zertifizierte Sicherheit & Nachhaltigkeit
- 05 _____ GREENCABLE® Light - Bestandteile
- 07 _____ GREENCABLE® Light - Im Überblick
Individuelle Möglichkeiten

THE CONTENTS AT A GLANCE

- 09 _____ Certified Safety & Sustainability
- 11 _____ GREENCABLE® Light - Components
- 13 _____ GREENCABLE® Light - Overview
Individual Possibilities

Zertifizierte Sicherheit & Nachhaltigkeit



ProCA-Produktpässe (QNG, DGNB 2023, EU-Tax)
Unsere digitalen Produktpässe (DPP) schaffen Transparenz über Materialien, Herkunft und Nachhaltigkeit und unterstützen Bauherren sowie Planer bei der Erfüllung von Anforderungen nach QNG, DGNB und EU-Taxonomie.



EPD (Umweltproduktdeklaration)
Eine EPD liefert verlässliche und standardisierte Umweltinformationen über den gesamten Lebenszyklus eines Produkts - von der Herstellung bis zum Recycling.



Dank der unkomplizierten Montage und der großen Flexibilität in der Gestaltung ist das GREENCABLE®- LIGHT System äußerst vielseitig und individuell erweiterbar. Es gewährleistet Langlebigkeit und eine stilvolle Optik bereits während der Wachstumsphase der Kletterpflanzen. Die speziellen A4-Edelstahlseile können horizontal, vertikal oder über Kreuz durch die Sockel geführt werden, wodurch grüne Muster an den Fassaden entstehen. Ohne den Einsatz besonderer Werkzeuge kombiniert diese Rankhilfe für Kletterpflanzen Technik und Einfachheit und ermöglicht eine Fassadenbegrünung ganz nach Ihren Vorstellungen.

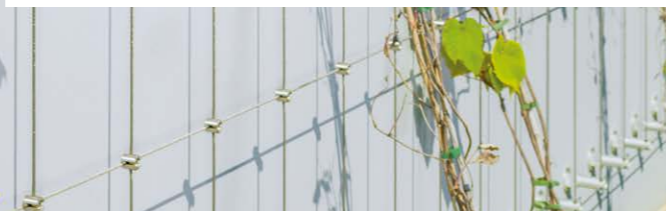

GREENCABLE LIGHT SYSTEM BESTANDTEILE

1x Aluminium-Sockel inkl. Zylinderklemmschraube,
1x Aluminium Abdeckscheibe und
1x Dichtscheibe aus Zellkautschuk für unebene Strukturen.



Dichtscheibe (G02-12-03)
Abdeckscheibe (G02-10-01 / G02-12-01)
Sockel (G02-10-85 / G02-10-140 / G02-12-85)

Als Rankhilfe dient ein hochflexibles Drahtseil aus rost- und säurebeständigem Edelstahl. Die Oberfläche der Aluminiumkomponenten ist farblos eloxiert und schimmert in mattem Silber. Das System lässt sich nachträglich mit Klettersprossen nachrüsten. Durch die metrische Gewindeaufnahme am Sockelfuß lässt sich das System mit allen gängigen Befestigungsarten kombinieren. Ausschreibungstexte und CAD-Datensätze stehen zum Download parat, videounterstützte Montageanleitungen runden den Service ab.



Klettersprosse ALU (G01-05-04)



Klettersprosse Kunststoff (G01-04-04)



Seilkreuz (858-0400-01)
Stab ø 4 mm (922-0400)

Greencable®-Sockel inkl. Zylinderschraube

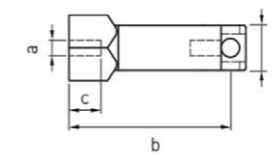

Artikel Nr.	a	b	c	ø d
G02-10-85	M10	85	30	29
G02-10-140	M10	140	30	29
G02-12-85*	M12	85	45	29

Werkstoff Aluminium eloxiert
* Mit seitlichen Madenschrauben

Greencable® Scheibe

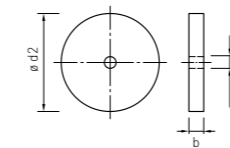

Artikel Nr.	b	ø d1	ø d2
G02-10-02	5	10,5	60
G02-12-02	8	12,5	60

Werkstoff Aluminium eloxiert

Dichtscheibe

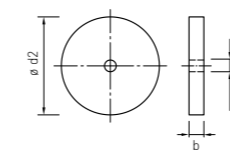

Artikel Nr.	b	ø d1	ø d2
G02-12-03	8	12	60

Werkstoff EPDM soft

Klettersprosse, Alu

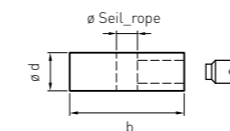

Artikel Nr.	b	ø d	ø Seil
G01-05-04	30	10	5,5

Werkstoff Aluminium eloxiert
Mit seitlicher Madenschraube

Klettersprosse, Kunststoff

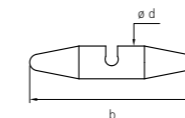

Artikel Nr.	b	ø d	ø Seil
G01-04-04	50	10	4

Werkstoff Kunststoff grau, UV-beständig

Seilkreuz verstellbar

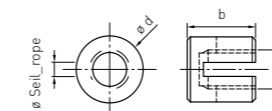

Artikel Nr.	a	b	ø d	ø Seil
858-0400-01	M12	19,5	20	4

Werkstoff 1.4401

IM ÜBERBLICK

INDIVIDUELLE MÖGLICHKEITEN

Typ / Bezeichnung	GREENCABLE® Light - vertikal
Pflanzenart	Schlinger / Winder gem. GREENCABLE® Pflanzenliste

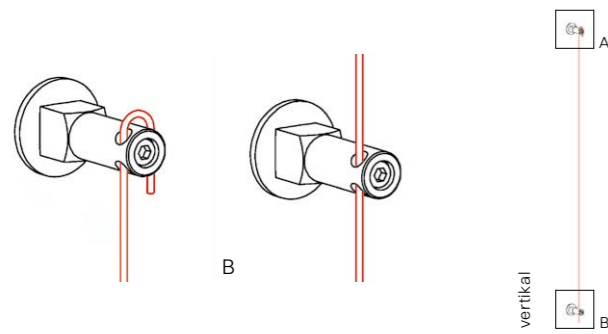

Typ / Bezeichnung	GREENCABLE® Light - horizontal
Pflanzenart	Spreizklimmer gem. GREENCABLE® Pflanzenliste

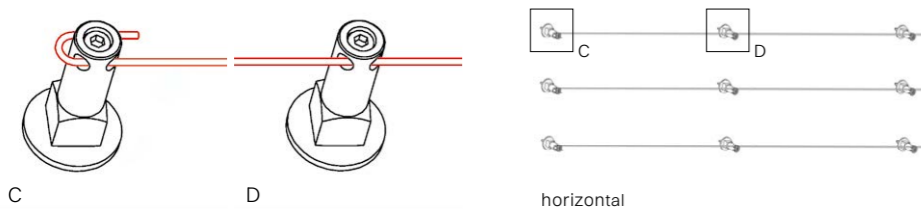

Typ / Bezeichnung	GREENCABLE® Light - rechtwinklig
Pflanzenart	Blatt-Stielranker / Sprossranker alternativ auch Schlinger / Winder oder Spreizklimmer gem. GREENCABLE® Pflanzenliste

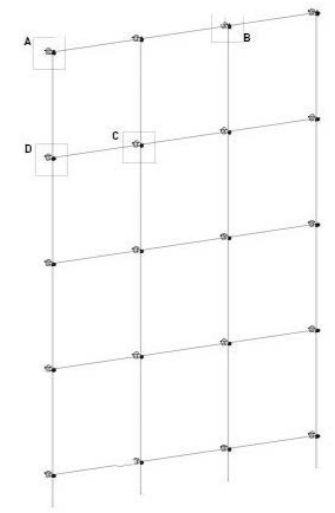
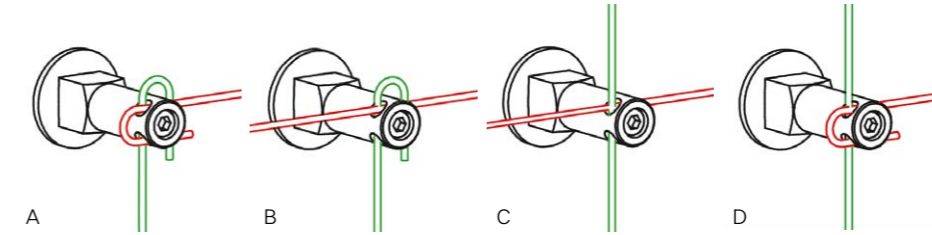

Typ / Bezeichnung	GREENCABLE® Light - rautenförmiger Seilverlauf als Gestaltungsmöglichkeit
Pflanzenart	Schlinger / Winder oder Spreizklimmer, je nach Formgestaltung auch Blatt-Stielranker / Sprossranker gem. GREENCABLE® Pflanzenliste

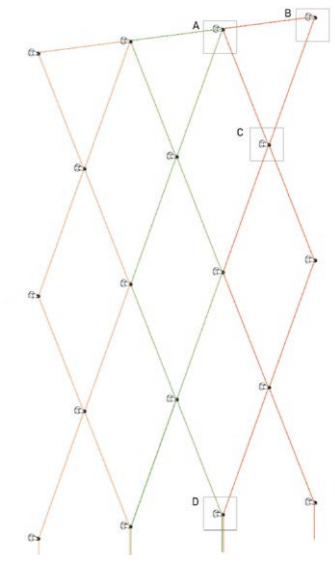
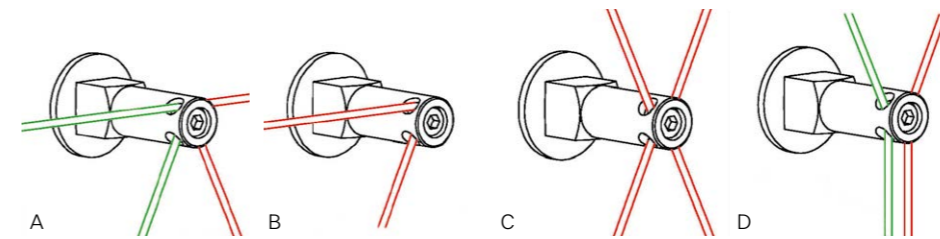

Certified Safety & Sustainability



ProCA product passports (QNG, DGNB 2023, EU-Tax)
Our Digital Product Passports (DPP) provide transparency regarding materials, origin and sustainability, and help clients and designers meet the requirements of QNG, DGNB and the EU Taxonomy.



EPD (Environmental Product Declaration)
An EPD provides reliable and standardised environmental information covering the entire life cycle of a product – from manufacture to recycling.



Thanks to the uncomplicated assembly and the great flexibility in design, the GREENCABLE®- LIGHT system is extremely versatile and can be individually expanded. It guarantees durability and a stylish appearance even during the growth phase of the climbing plants. The special A4 stainless steel cables can be guided horizontally, vertically or crosswise through the bases, creating green patterns on the facades. Without the use of special tools, this trellis system combines technology and simplicity and enables facade greening exactly as you want it.



GREENCABLE LIGHT SYSTEM THE SYSTEM CONSISTS OF

- 1x GREENCABLE Base with screw,
- 1x GREENCABLE-Disc and
- 1x Sealing disc Ø60mm - made of cellular rubber for uneven structures.

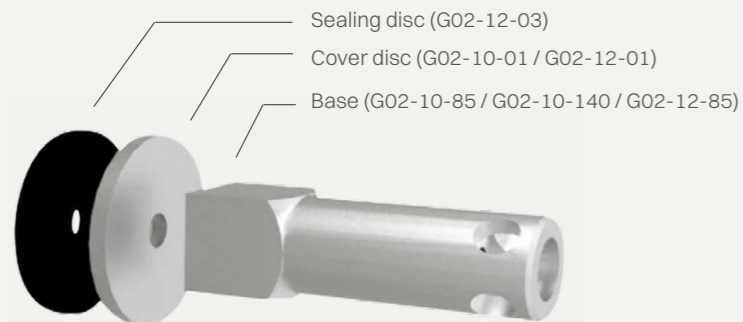

A highly flexible wire rope made of rust- and acid-resistant stainless steel serves as a climbing aid. The surface of the aluminum components is clear anodized and shimmers in matt silver. The system can also be retrofitted with climber studs. Thanks to the metric thread on the base foot, the system can be combined with all common types of fastening. Specification texts and CAD datasets are available for download, and videosupported installation instructions complete the service.



climber stud (G01-05-04)
with screw



climber stud - plastic
(G01-04-04)



cross clamp (858-0400-01)
rod ø 4 mm (922-0400)

Greencable®- Base with screw

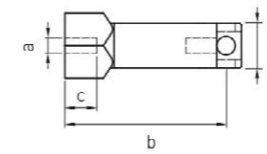

part number	a	b	c	ø d
G02-10-85	M10	85	30	29
G02-10-140	M10	140	30	29
G02-12-85*	M12	85	45	29

Material Aluminium anodised
* with side clamping screw

Greencable® Disc

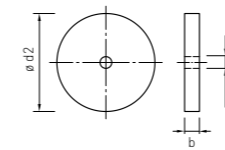

part number	b	ø d1	ø d2
G02-10-02	5	10,5	60
G02-12-02	8	12,5	60

Material Aluminium anodised

Sealing Disc

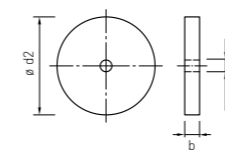

part number	b	ø d1	ø d2
G02-12-03	8	12	60

Material EPDM soft

Climber stud with screw

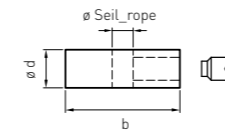

part number	b	ø d	ø cable
G01-05-04	30	10	4

Material Aluminium anodised
with side clamping screw

Climber stud - plastic

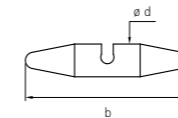

part number	b	ø d	ø cable
G01-04-04	50	10	4

Material plastic grey, UV resistant

Cross clamp, adjustable

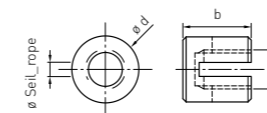

part number	a	b	ø d	ø cable
858-0400-01	M12	19,5	20	4

Material AISI 316

OVERVIEW

INDIVIDUAL POSSIBILITIES

Type / Description	GREENCABLE® Light - vertical
Plant species	Climber / Winders according to GREENCABLE plant list

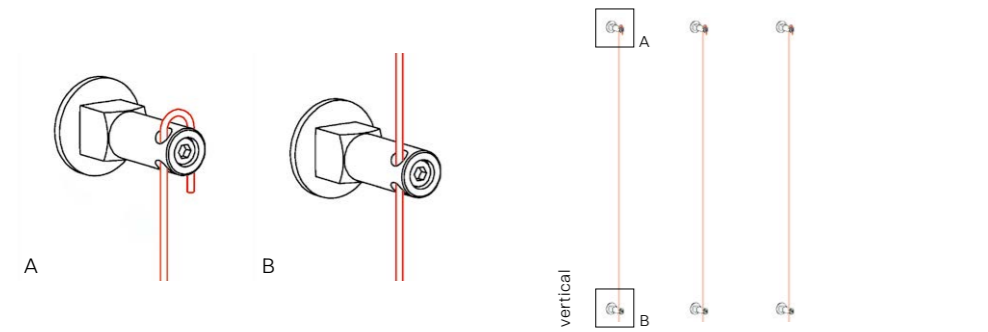

Type / Description	GREENCABLE® Light - horizontal
Plant species	spreading climber according to GREENCABLE plant list

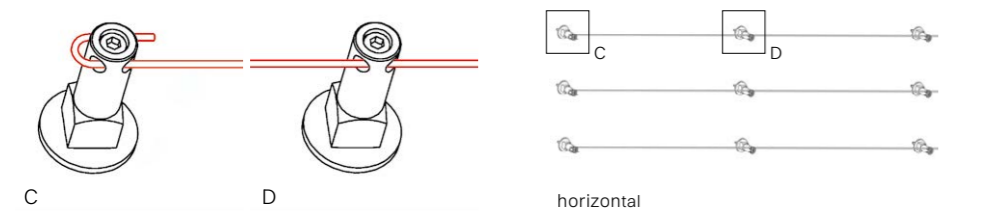

Type / Description	GREENCABLE® Light - right angle
Plant species	Leaf stem and shoot Climbing alternativ Climber / Winders / Spreading climber according to GREENCABLE plant list

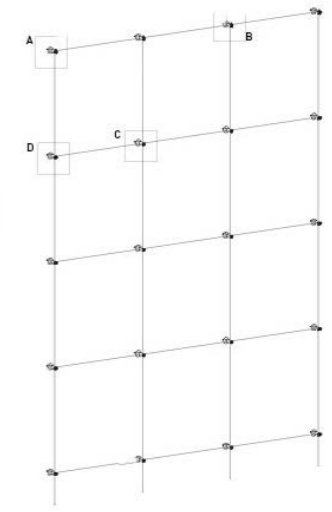
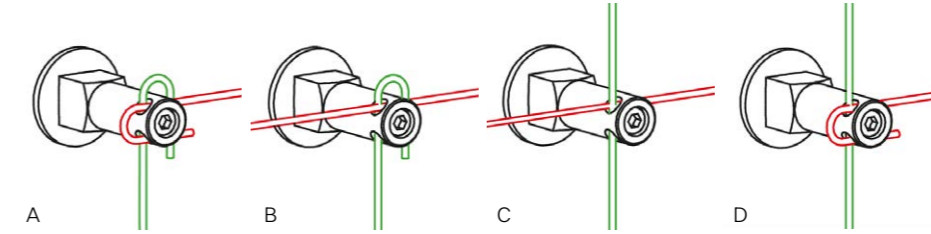

Type / Description	GREENCABLE® Light - rhombic-shaped cable pattern as a design option
Plant species	Climber / Winders or spreading climber, depending on the shape, also leaf stem climbers / shoot climbers according to the GREENCABLE® plant list

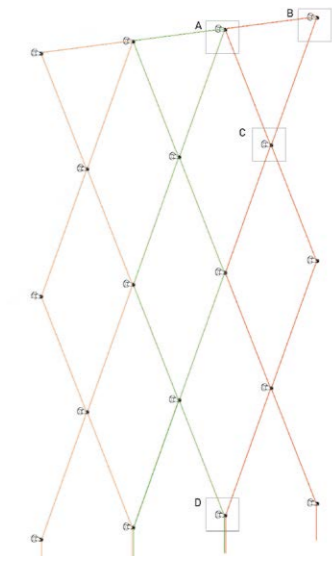
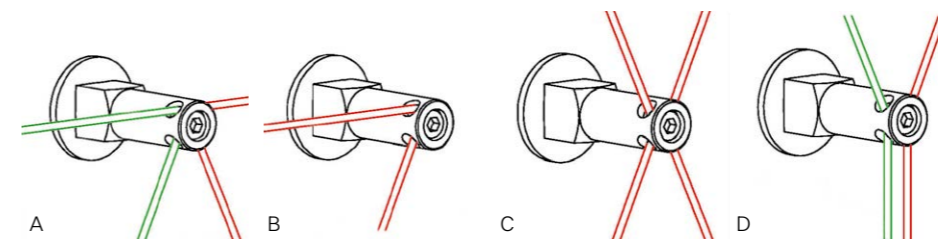

Zertifizierte Sicherheit & Nachhaltigkeit
Certified Safety & Sustainability



Carl Stahl
ARCHITEKTUR



+49 (0) 7162 948 150 700
seilsysteme@carlstahl-arc.com

greencable.eu
carlstahl-architektur.com

Version 05/2026